

Spine Set for lumbar retraction

LT-Set für die lumbare Retraktion
LT-Set for lumbar retraction

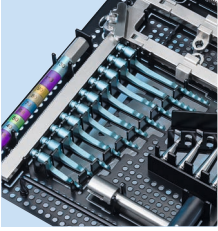



Ihre Adresse für chirurgisches Qualitätsinstrumentarium "Made in Germany", hergestellt an unserem Standort in Emmingen bei Tuttlingen.

medicalbees steht für höchste Qualität, Schnelligkeit und Effizienz. Wir finden für Sie die technisch und wirtschaftlich optimalste Lösung.

Höchste Qualität zu fairen Preisen. Sprechen Sie uns an, um das komplette medicalbees Produktprogramm kennenzulernen!

Weitere Informationen erhalten Sie auf medical-bees.de oder per E-Mail über sales@medical-bees.de.

Your address for surgical quality instruments "Made in Germany", manufactured at our site in Emmingen near Tuttlingen.

medicalbees stands for highest quality, speed and efficiency. We will find the technically and economically optimal solution for you.

Highest quality at fair prices. Contact us to get to know the complete medicalbees product range!

For further information please visit: medical-bees.de or by e-mail at sales@medical-bees.de.

1 LT-Set	3
<i>LT-Set</i>	
2 LT Komponenten	4
<i>LT Components</i>	
3 LT Valven	5-6
<i>LT Blades</i>	
4 LT Zubehör	7
<i>LT Accessories</i>	

made in GERMANY



LT-Set für die lumbare Retraktion

LT-Set for lumbar retraction

- Variabilität durch Abwinkelung des Spreizers. Gelenke halten in Position
- Valven werden über snap-lock eingehängt
- Valven 360° rotierbar, Haken mit Fixierungspin
- Einfache, leicht verschiebbare Adaption der Valven mittels zwei verschiedener Valvenaufnahmen

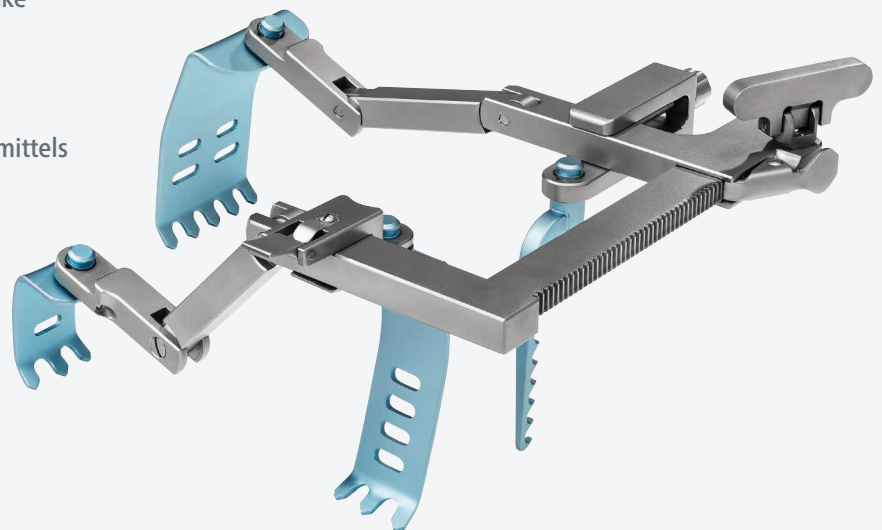

- *Double-hinged retractor for optimal positioning of the spreader. Joints hold in position*
- *Blades are easily connected via snap-lock*
- *Blades 360° rotatable, hook with fixation pin*
- *Simple, easily movable adaptation of blades using two different types of blade connectors*

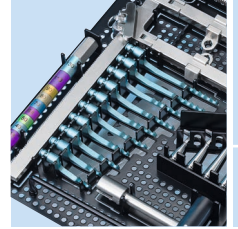

MB1-10-985-20

LT-Set für die lumbare Retraktion im Siebkorb, Maße in mm: 540 x 253 x 170 mm
 LT-Set for lumbar retraction in tray, dimensions in mm: 540 x 253 x 170 mm

Das neue LT-Set: Das neue Lumbarretraktionsset

- Universell einsetzbar im Bereich der lumbaren und thorakalen Wirbelsäulenchirurgie
- Valvenaufnahmen mit Schnellverschluss oder Schraube stehen zur Verfügung zur Adaption an den Retraktor
- Separater Handgriff zur Adaption von Valven für manuelle Retraktion verfügbar
- Komplettes Set wird in 3 Einsätzen im Siebkorb mit Deckel gelagert. Alle Aufnahmen sind speziell beschichtet zum Schutz der Instrumente während Transport und Sterilisation
- Alle Valven aus Titan und mit der Valvenlänge signiert zur einfachen Identifikation und Verwendung
- Set umfasst alle im Prospekt abgebildeten Produkte

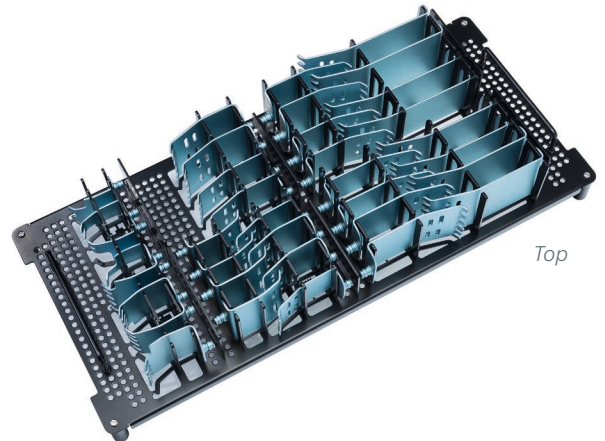

Top



Middle

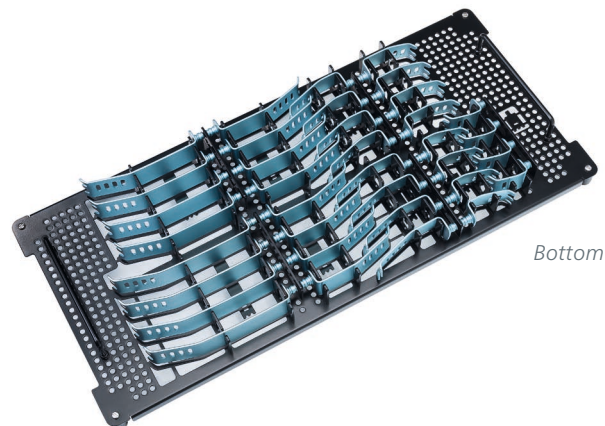

Bottom

The new LT-Set: The new lumbar retractor system

- To be used for lumbar and thoracic spinal procedures
- Blade connectors with quick coupling or screw are available for the adaption to the retractor
- Separate handle for manual blade retraction available
- Complete set with 3 inserts in tray with lid. All storage elements are specially coated to protect instrument surface during transport and sterilization
- All blades from Titanium and marked with length for ease of identification and use
- Set includes all products figured in the catalogue

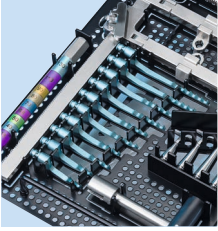

Titan | Titanium



Spreizer aus Edelstahl mit Gelenk, Spreizweite: 209 mm
 Retractor stainless steel, opening width: 209 mm

Artikelnummer Article Number	Set Set
MB1-10-985-25	1



Spreizer aus Titan mit Doppelgelenk
 Retractor titanium, double-hinged

Artikelnummer Article Number	Spreizweite Opening width	Set Set
MB1-10-985-30	102 mm	1
MB1-10-985-33	209 mm	nicht enthalten not included



Valvenaufnahme mit Verschluss
 Blade connector quick coupling

Artikelnummer Article Number	Set Set
MB1-10-985-35	4



Valvenaufnahme mit Rändelschraube
 Blade connector screw connection

Artikelnummer Article Number	Set Set
MB1-10-985-40	4



T-Handgriff zum Spreizen der LT Retraktoren
 T-Handle for spreading of LT retractors

Artikelnummer Article Number	Set Set
MB1-10-985-55	1

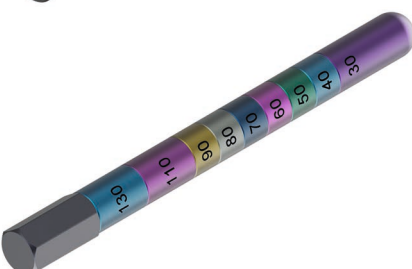

LT Tiefenmessstab
 LT Depth gauge

Artikelnummer Article Number	Set Set
MB1-10-985-50	1

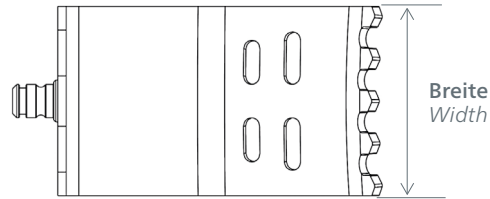
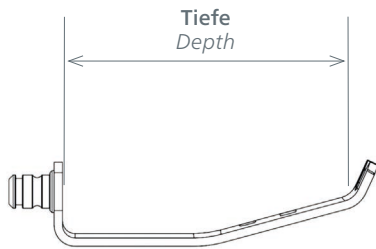
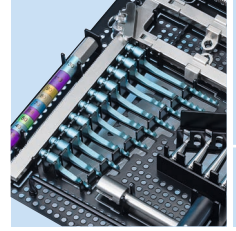

LT Valve, 3-zahnig, 24 mm breit
LT Blade, 3 teeth, 24 mm wide

Artikelnummer Article Number	Tiefe Depth	Set Set
MB1-10-986-05	30 mm	4
MB1-10-986-10	40 mm	4
MB1-10-986-15	50 mm	4
MB1-10-986-20	60 mm	4
MB1-10-986-25	70 mm	4
MB1-10-986-27	80 mm	4
MB1-10-986-30	90 mm	4
MB1-10-986-35	110 mm	4
MB1-10-986-40	130 mm	4

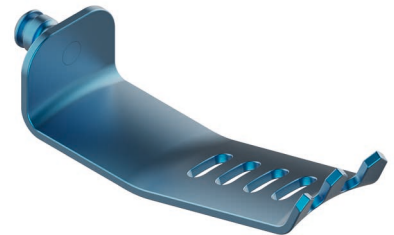

LT Valve, 5-zahnig, 45 mm breit
LT Blade, 5 teeth, 45 mm wide

Artikelnummer Article Number	Tiefe Depth	Set Set
MB1-10-987-05	50 mm	2
MB1-10-987-10	60 mm	2
MB1-10-987-15	70 mm	2
MB1-10-987-20	80 mm	2
MB1-10-987-25	90 mm	2
MB1-10-987-30	110 mm	2
MB1-10-987-35	130 mm	2

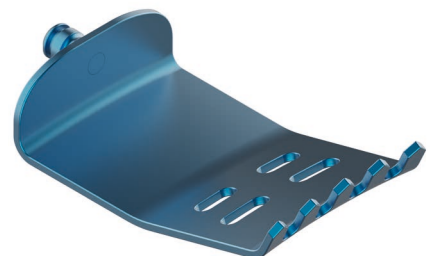

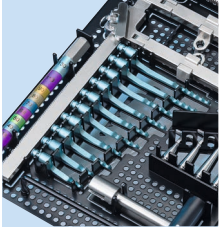

 LT Valve, 6-zahnig, 60 mm breit
 LT Blade, 6 teeth, 60 mm wide

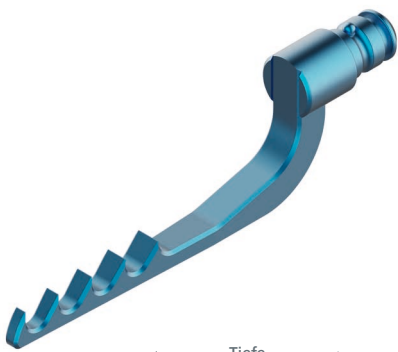
Artikelnummer Article Number	Tiefe Depth	Set Set
MB1-10-988-05	50 mm	2
MB1-10-988-10	60 mm	2
MB1-10-988-15	70 mm	2
MB1-10-988-20	80 mm	2
MB1-10-988-25	90 mm	2
MB1-10-988-30	110 mm	2
MB1-10-988-35	130 mm	2

 LT Haken, mit Zähnen
 LT hook, with teeth

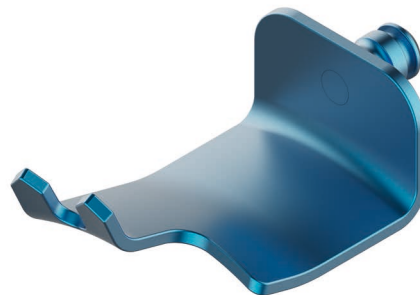
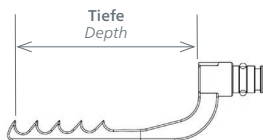
Artikelnummer Article Number	Tiefe Depth	Zähne Teeth	Set Set
MB1-10-989-05	34 mm	3	2
MB1-10-989-10	44 mm	4	2
MB1-10-989-15	54 mm	5	2
MB1-10-989-20	64 mm	6	2
MB1-10-989-25	84 mm	7	2



links / left

 LT Valve, links und rechts
 LT Blade, left and right

Artikelnummer Article Number	Beschreibung Description	Breite Width	Tiefe Depth	Zähne Teeth	Set Set
MB1-10-990-05	links / left	30 mm	40 mm	2	2
MB1-10-990-15	rechts / right	30 mm	40 mm	2	2
MB1-10-990-10	links / left	60 mm	45 mm	5	2
MB1-10-990-20	rechts / right	60 mm	45 mm	5	2

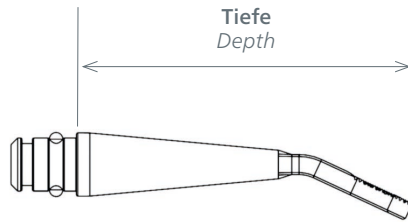
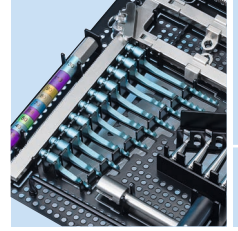

T-Valve, 25 mm breit
T-Blades Bar, 25 mm wide

Artikelnummer <i>Article Number</i>	Tiefe <i>Depth</i>	Set <i>Set</i>
MB1-10-990-60	40 mm	1
MB1-10-990-70	50 mm	1
MB1-10-990-80	60 mm	1
MB1-10-990-90	70 mm	1



LT Handgriff zum Einbringen von Valven
LT handle for manual blade retraction

Artikelnummer <i>Article Number</i>	Beschreibung <i>Description</i>	Gesamtlänge <i>Total length</i>	Set <i>Set</i>
MB1-10-985-45	gebogen <i>curved</i>	175 mm	2



MB1-10-985-10

Siebkorb mit Deckel und 3 Einsätzen für LT-Set (ohne Instrumente), Maße in mm: 540 x 253 x 170 mm
Tray with lid and 3 inserts for LT-Set (without instruments), dimensions in mm: 540 x 253 x 170 mm

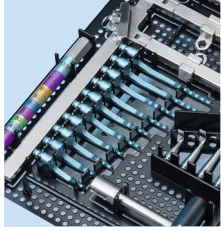

Das könnte Sie auch interessieren | *This could also interest you*



Kopfhaltungssystem
Cranial stabilization system

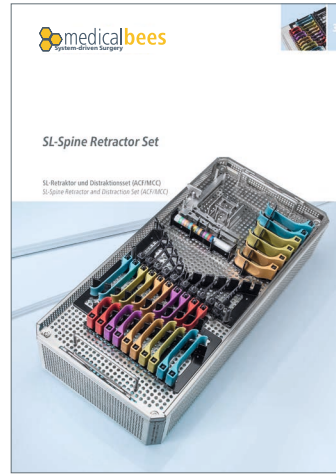

SL-Re Retraktor Set
SL-Spine Retractor Set

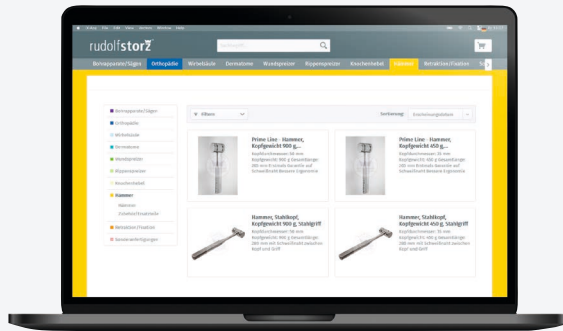

Neue Produktdatenbank!

New product database!

Lernen Sie unsere Produkte mit Hilfe unserer neuen Produktdatenbank kennen.

Get to know our products with our new product database.

Änderungen der technischen Angaben und Maße liegen in unserem Ermessen. Modelländerungen vorbehalten. Ohne unsere ausdrückliche schriftliche Genehmigung darf dieses Printmedium weder im Gesamten noch auszugsweise kopiert oder nachgedruckt werden.
Changes in technical specifications and dimensions are at our discretion. Subject to modification. Without our explicit written approval this print media may not be copied or reprinted as a whole or in extracts.

